

ART. 380

Gruppo composto da tre elementi per eseguire la profilatura di antine.
L' utensile e' corredato di una sola sagoma a scelta. Su richiesta , possibilita' di ottenere i quattro profili , intercambiando i coltelli sagomati.

Cutterset composed of tree elements. This set is designed for carrying out profile of kitchen doors. The cutterset is supplied with only one profile, which can be chosen. Om request it is possible to obtain the four profiles by changing tips.

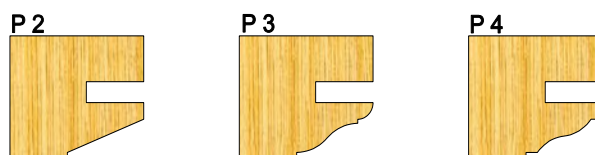
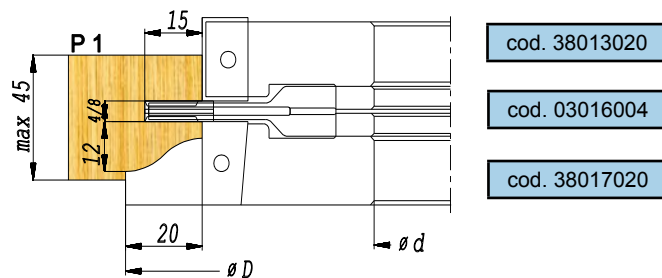

ART. 385

Gruppo composto da tre elementi per eseguire il controprofilo di antine.
L' utensile e' corredato di una sola sagoma a scelta. Su richiesta , possibilita' di ottenere i quattro profili , intercambiando i coltelli sagomati.

Cutterset composed of tree elements. This set is designed for carrying out contrepfile of kitchen doors. The cutterset is supplied with only one profile, which can be chosen. Om request it is possible to obtain the four profiles by changing tips.

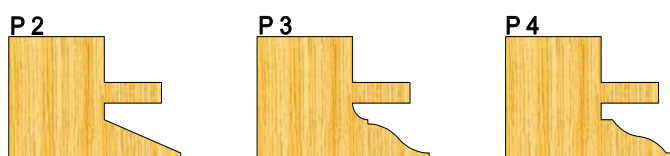
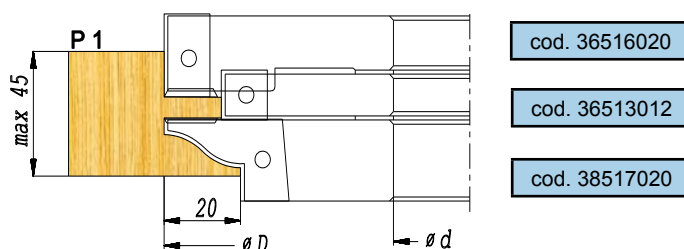

ART. 430

Utensile per antine
Set composto da due gruppi su mozzo per eseguire sagoma e
controsagoma

Cutter for kitchen door

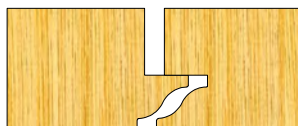
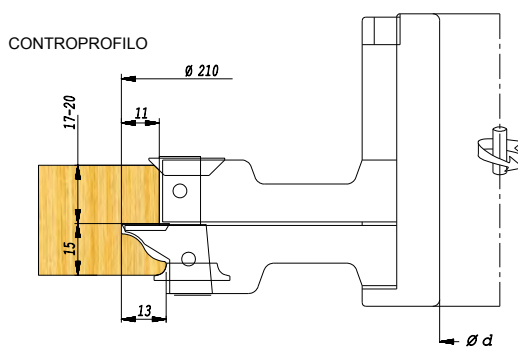
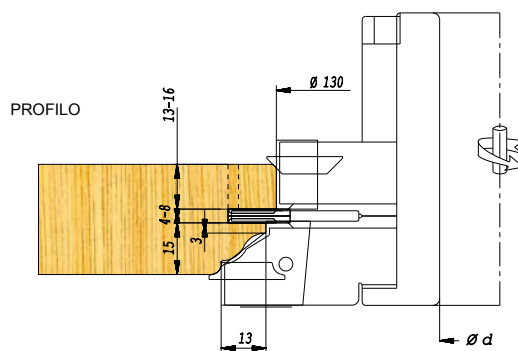

ART. 420

VERSIONE ECONOMICA

Gruppo composto da due elementi per eseguire sagoma e controsagoma di antine.
L' utensile e' corredato di una sola sagoma a scelta. Su richiesta , possibilita' di ottenere i quattro profili , intercambiando i coltelli sagomati.

ECONOMIC VERSION

Cutterset composed of two elements .This set is designed for carrying out profile and counterprofile of kitchen doors. The cutterset is supplied with only one profile, which can be chosen. On request it is possible to obtain the four profiles by changing tips.

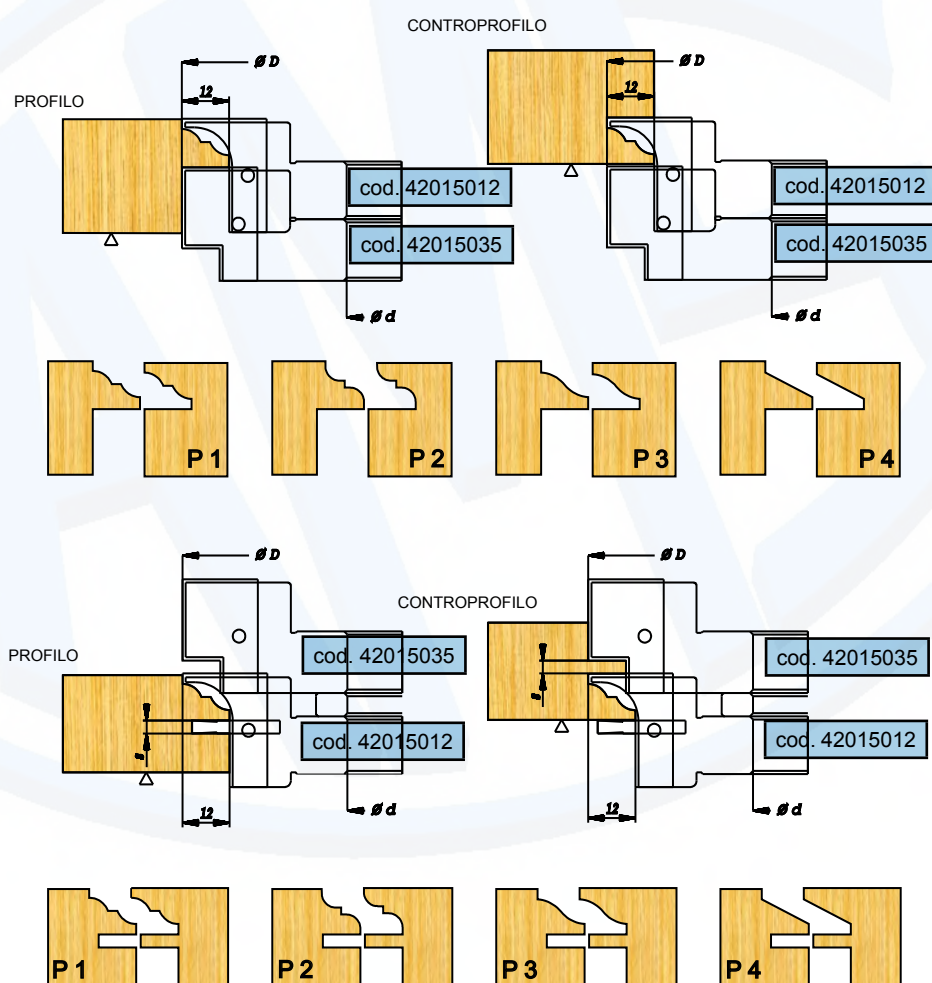

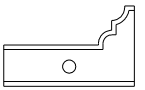
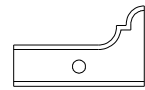
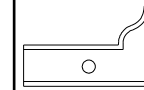
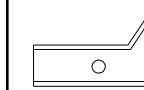
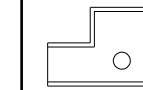
Coltelli di ricambio Spare knives					
codice / code	92423001 (P1)	92423201 (P2)	92423401 (P3)	92423601 (P4)	92423801 (P5)

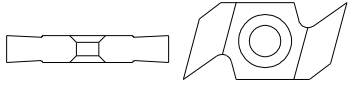
Coltelli di ricambio Spare knives	
codice / code	16010400 (S=4) 16010500 (S=5) 16010600 (S=6)

ART. 410

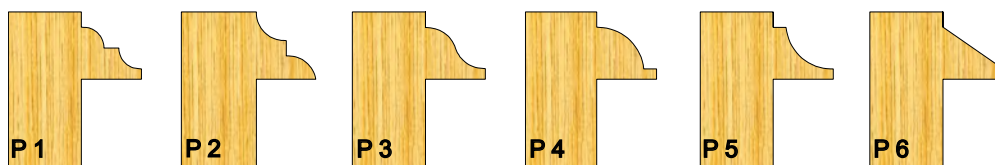
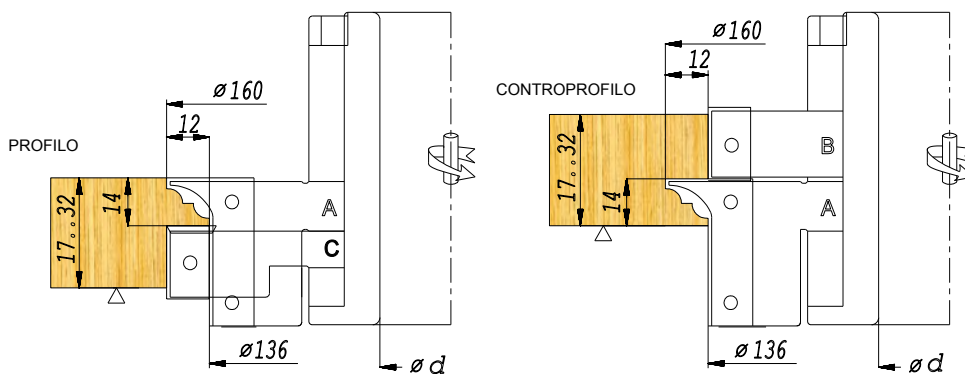

Coltelli di ricambio Spare knives					
codice / code	01156201 (P1)	02156201 (P2)	03156201 (P3)	04156201 (P4)	05156201 (P5)

Coltelli di ricambio Spare knives						
codice / code	06156201 (P6)	12012000	14140200	16010400 (S=4)	16010500 (S=5)	16010600 (S=6)

ART. 410

Gruppo composto da tre elementi montati su mozzo per eseguire sagoma e controsagoma di antine. L' utensile e' corredato di una sola sagoma a scelta. Su richiesta , possibilita' di ottenere i sei profili , intercambiando i coltelli sagomati.

Cutterset composed of tree elements mounted on sleeve. This set is designed for carrying out profile and counterprofile of kitchen doors. The cutterset is supplied with only one profile, which can be chosen. Om request it is possible to obtain the six profiles by changing tips.

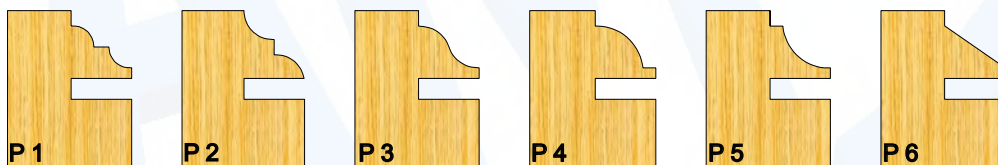
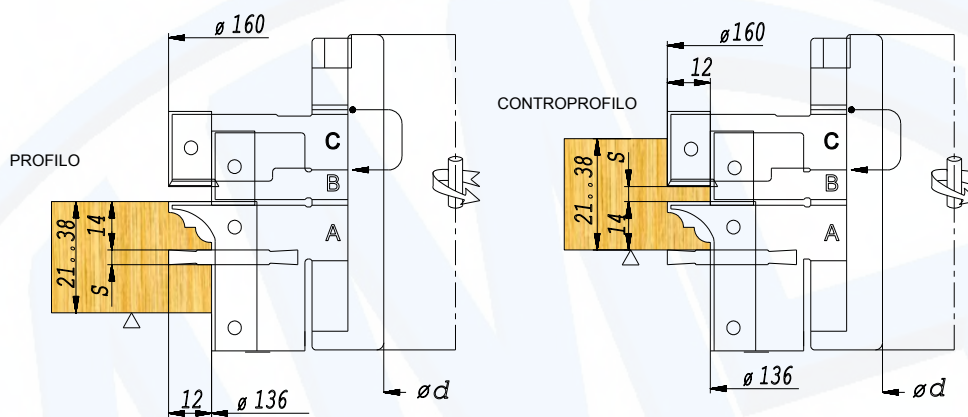

ART. 390

Gruppo composto da tre elementi per eseguire la profilatura di porte.
L' utensile e' corredato di una sola sagoma a scelta. Su richiesta , possibilita' di ottenere i quattro profili , intercambiando i coltelli sagomati.

Cutterset composed of tree elements. This set is designed for carrying out profile of doors. The cutterset is supplied with only one profile, which can be chosen. Om request it is possible to obtain the four profiles by changing tips.

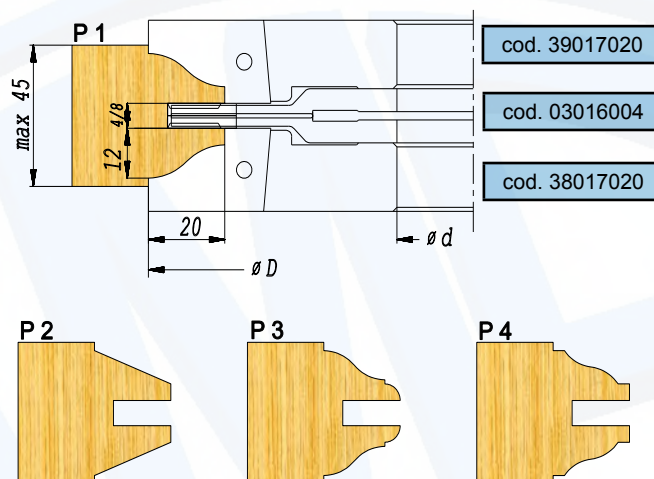

ART. 395

Gruppo composto da tre elementi per eseguire il controprofilo di porte.
L' utensile e' corredato di una sola sagoma a scelta. Su richiesta , possibilita' di ottenere i quattro profili , intercambiando i coltelli sagomati.

Cutterset composed of tree elements. This set is designed for carrying out contreprofile of doors. The cutterset is supplied with only one profile, which can be chosen. Om request it is possible to obtain the four profiles by changing tips.

