

SEZ. C-C

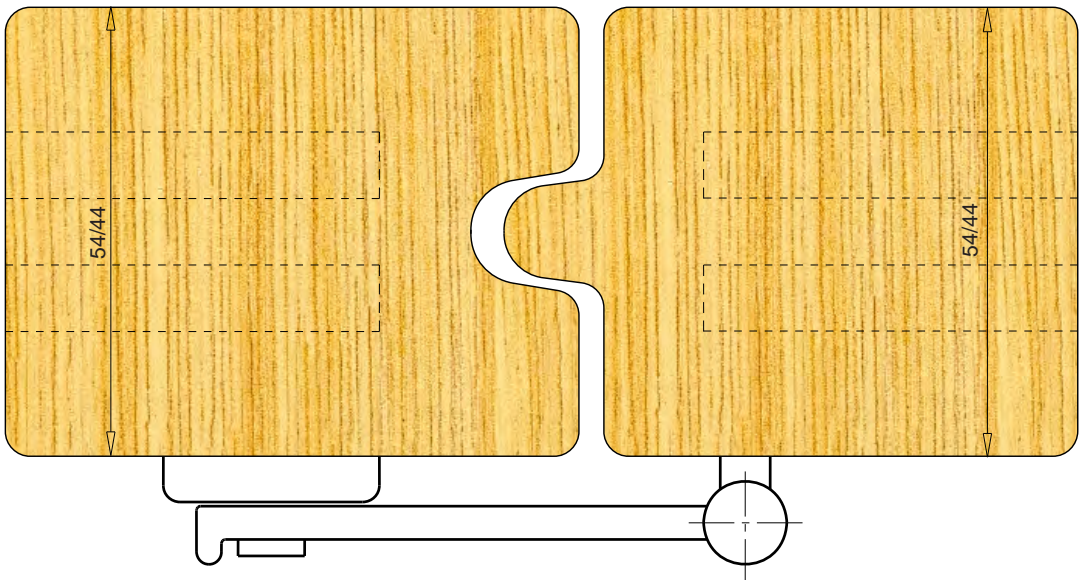

SEZ. A-A

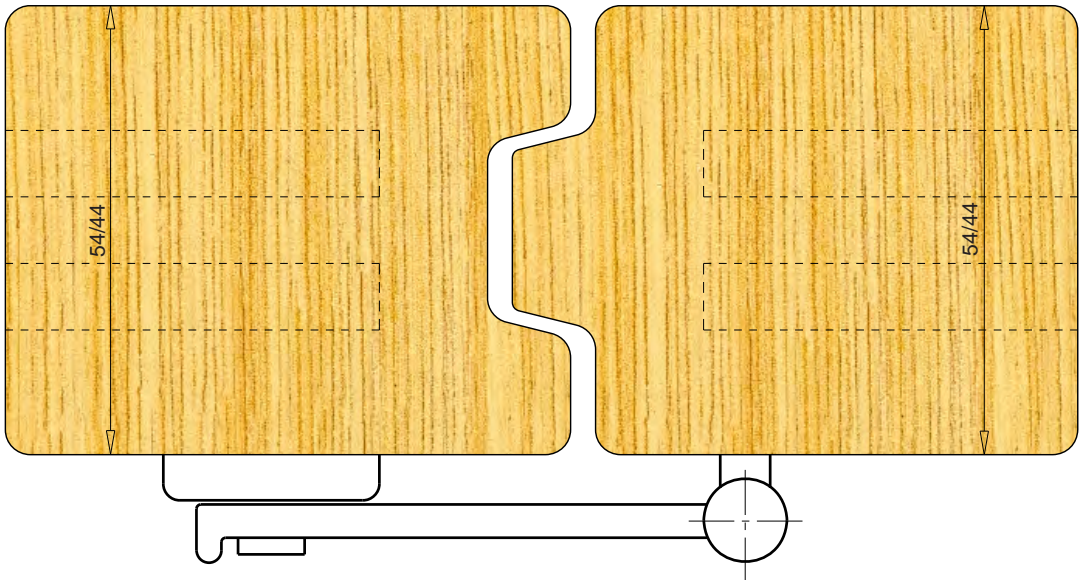
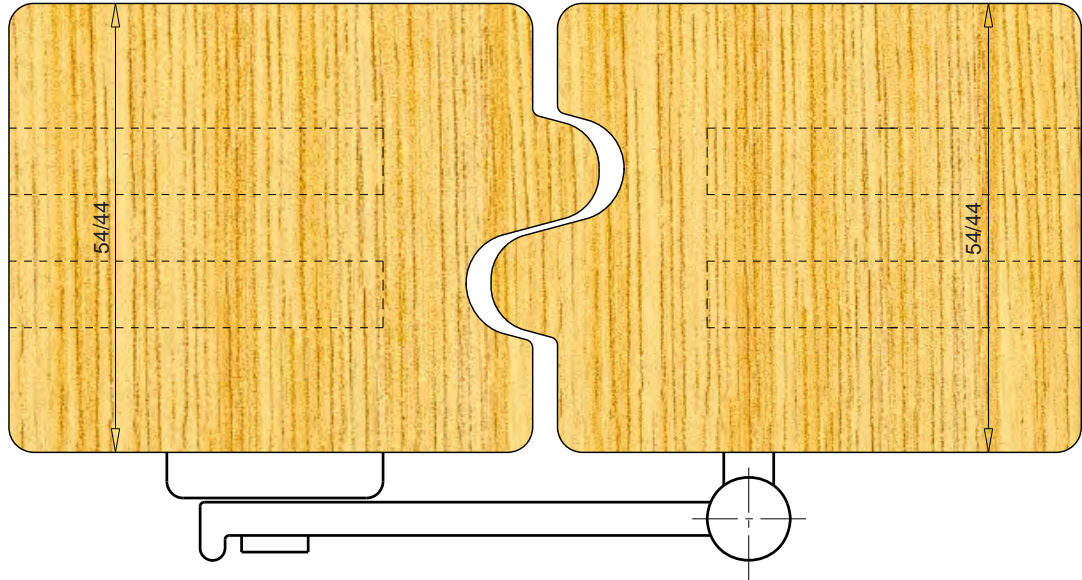
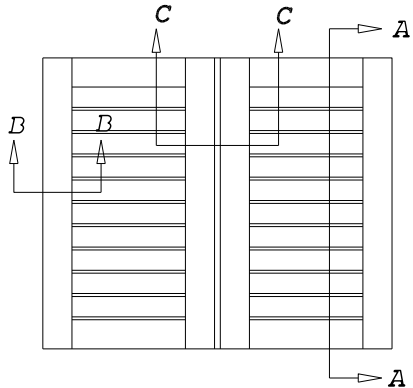
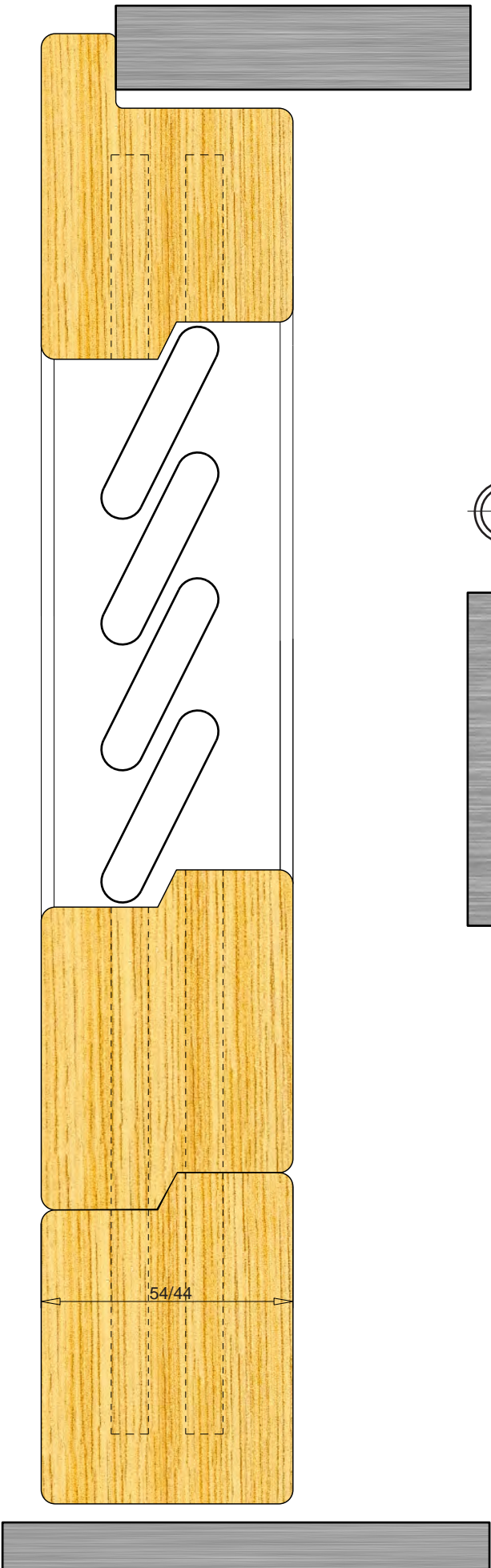

SEZ. B-B

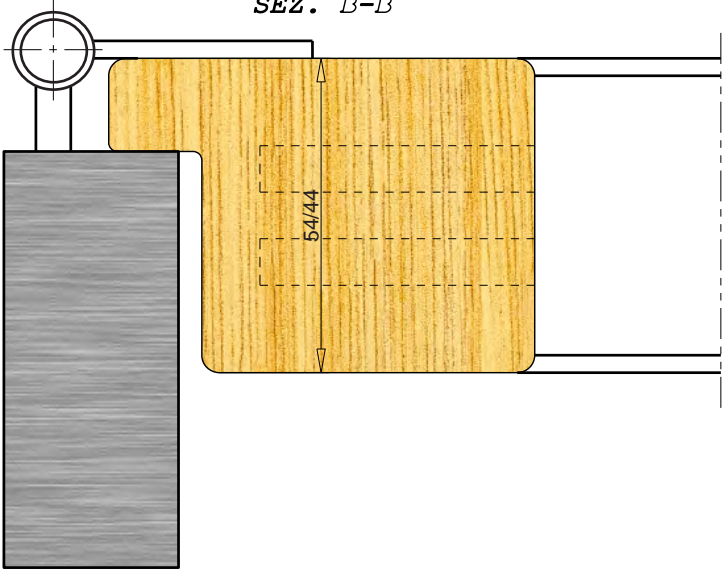

SEZ. C-C

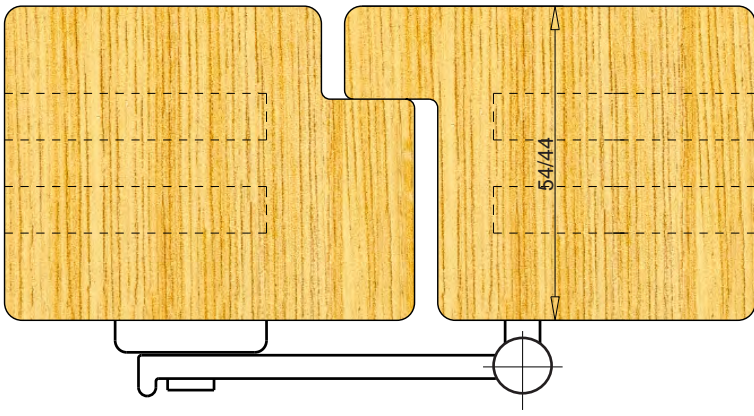

SEZ.A-A

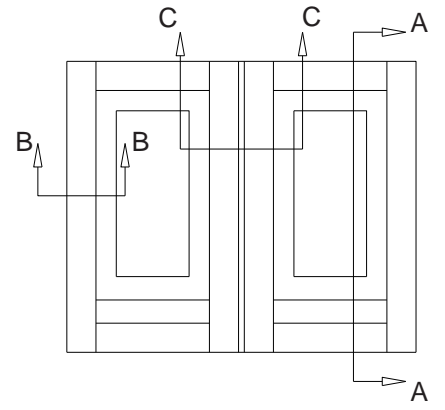
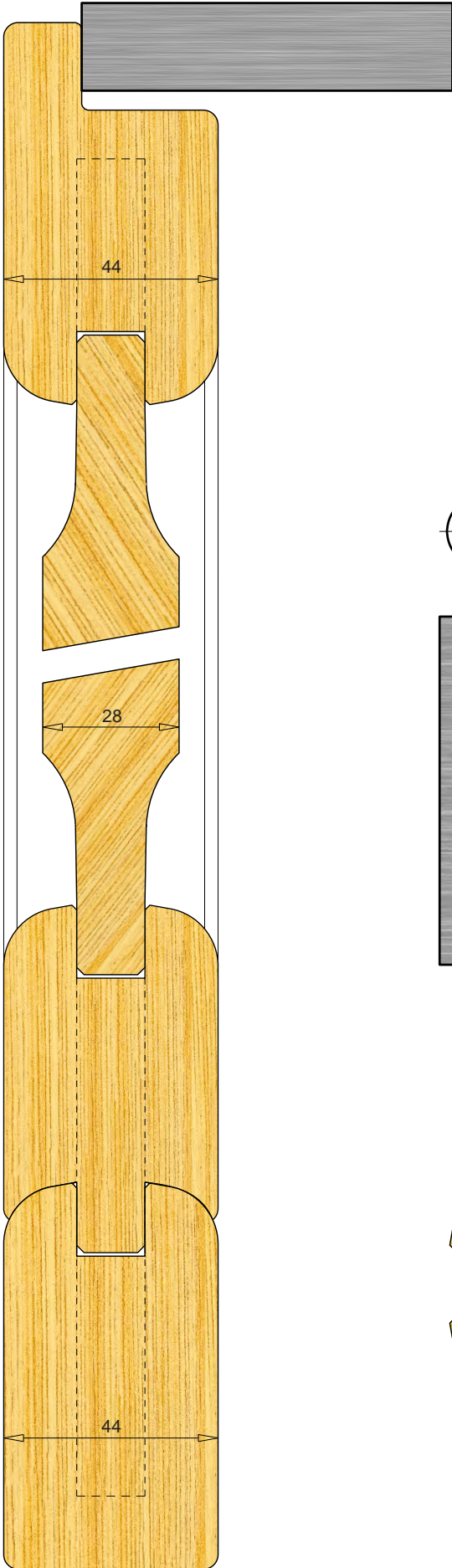

SEZ.B-B

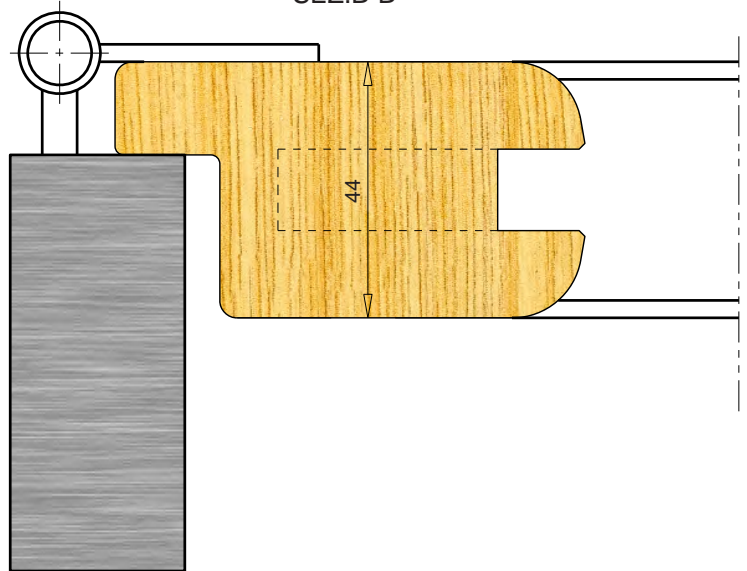

SEZ.C-C

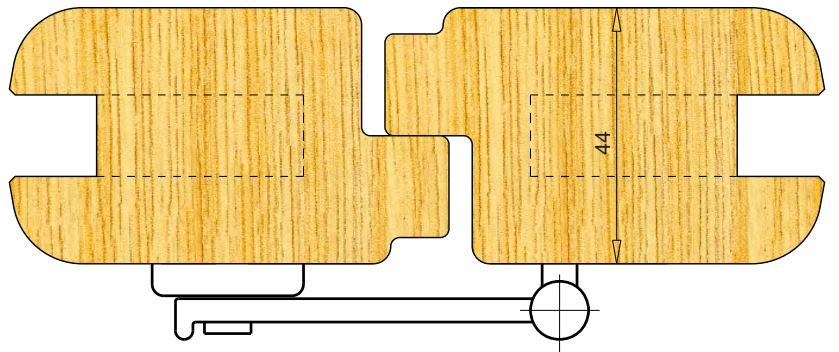

SEZ.A-A

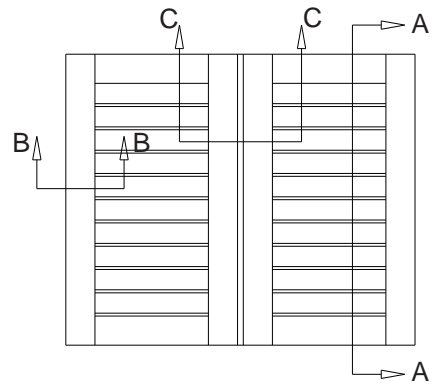
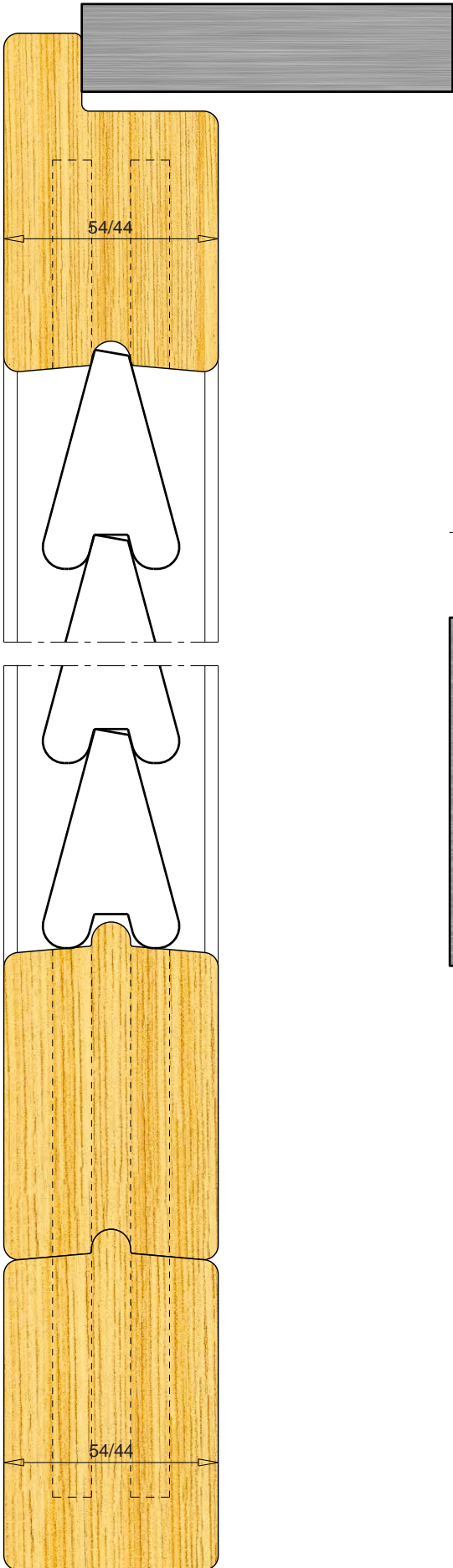

SEZ.B-B

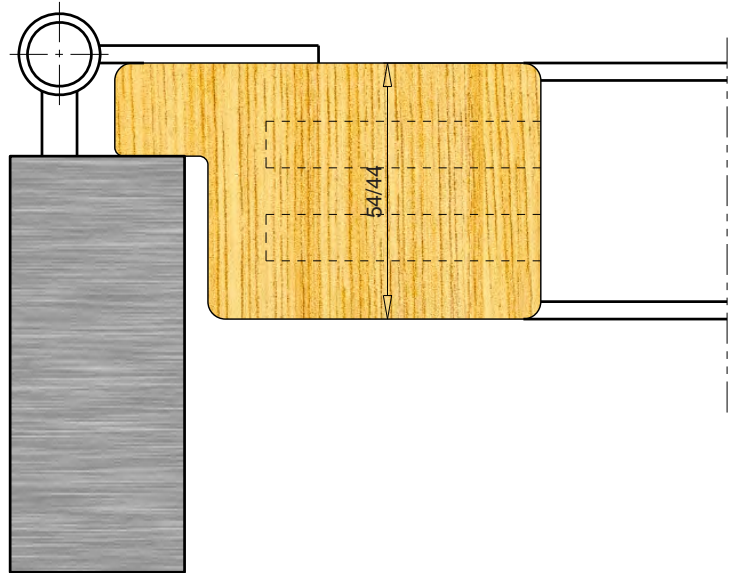

SEZ.C-C

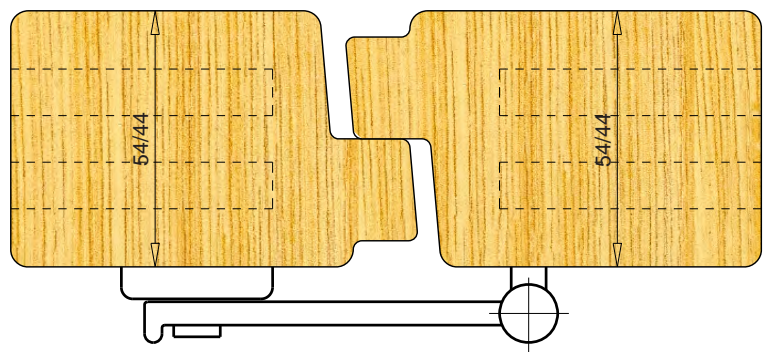

SEZ.A-A

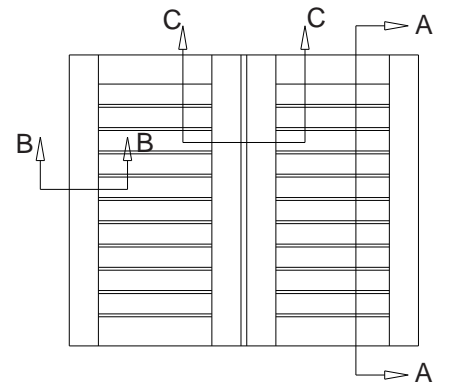
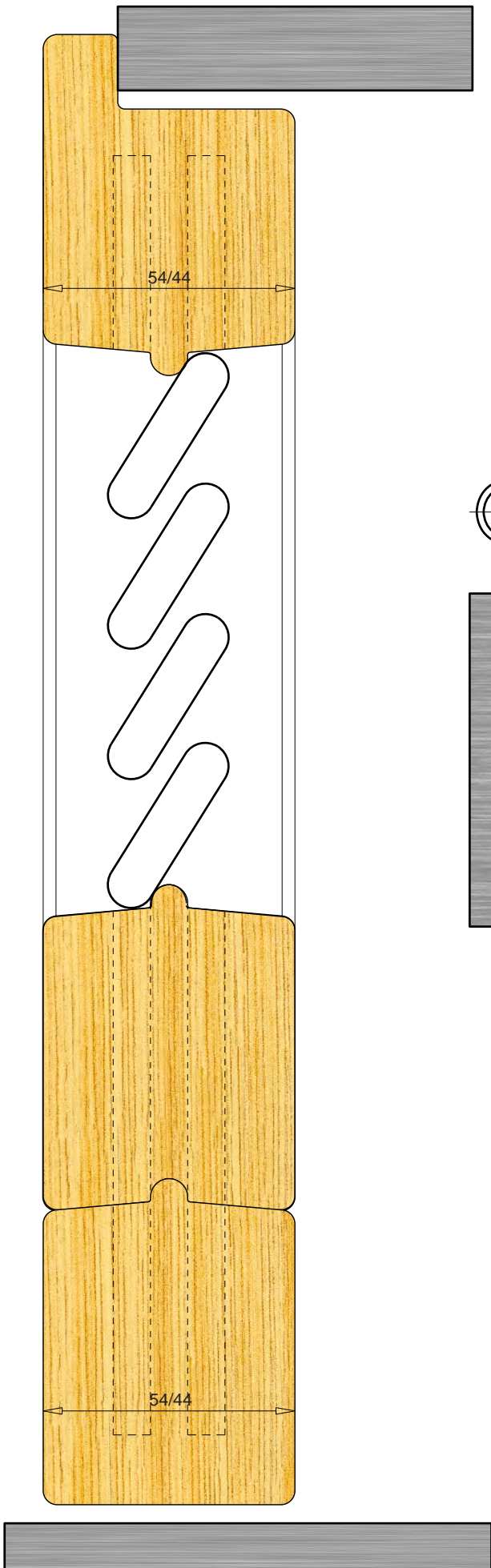

SEZ.B-B

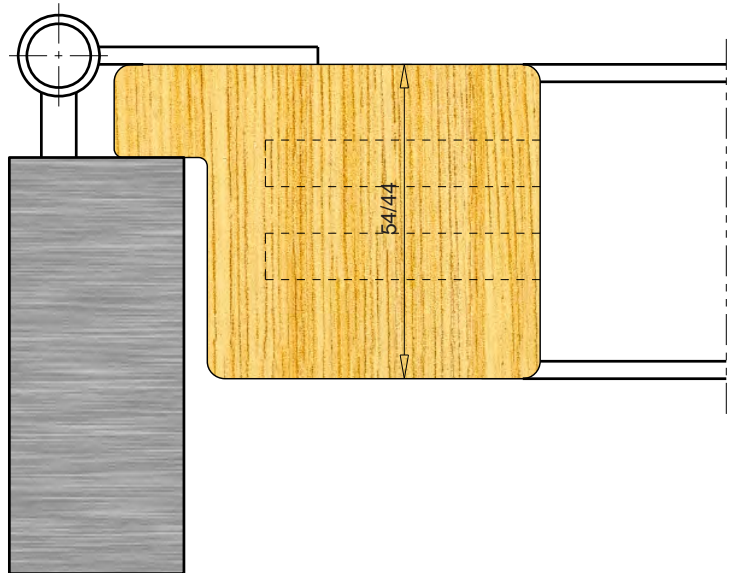

SEZ.C-C

