

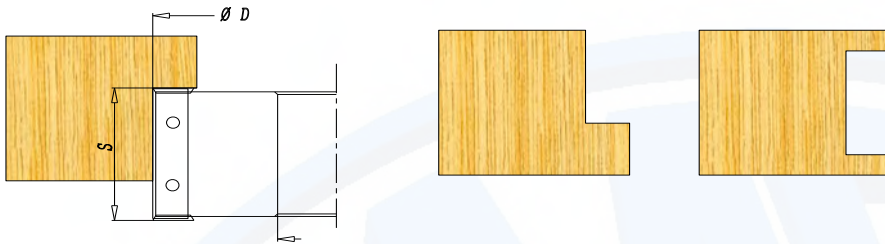



# ART. 010

Testa per battute in acciaio con angolo assiale alternato

Rebating cutterhead in steel with alternate shear angle

COD.	D mm	d mm	S	Z
01012550	125	30/35 40/50	50	2+2
01012560	125	30/35 40/50	60	2+2
01015050	150	30/35 40/50	50	2+2
01015060	150	30/35 40/50	60	2+2

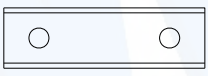

Coltelli di ricambio Spare knives			
codice / code	12015000 ( S=50 )	12015000 ( S=60 )	14140200





# ART. 020

Testa per battute in acciaio con angolo assiale alternato  
con levaspigoli regolabili

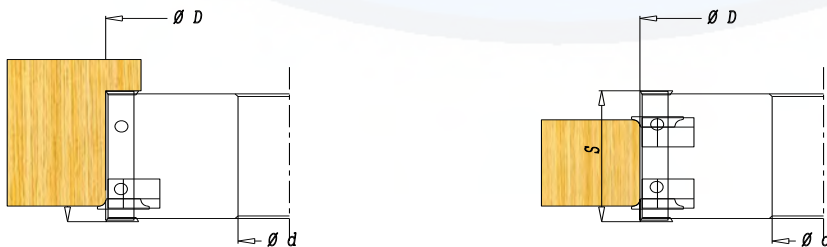
Rebating cutterhead in steel with alternate shear angle  
and adjustable chamfer cutters

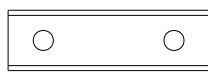
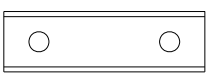
COD.	D mm	d mm	S	Z
02012550	125	30/35 40/50	50	2+2
02012560	125	30/35 40/50	60	2+2
02015050	150	30/35 40/50	50	2+2
02015060	150	30/35 40/50	60	2+2



Coltelli di ricambio Spare knives					
codice / code	12015000 ( S=50 )	12016000 ( S=60 )	14140200	16302200	16452200

# ART. 100

Fresa a spessore variabile per eseguire svariati tipi di profilo.  
 Quattro taglienti, quattro rasanti, quattro settori integrali in HM,  
 quattro levaspigoli per risolvere qualsiasi esigenza.

Adjustable grooving cutter. This cutterhead allows to obtain various profiles. Four cutting edges, four scribing cutters four grooving cutters in full HM, four chamfer cutters for any requirement

COD.	D mm	d mm	S	LS
10016045	160	30/35 40/50	31-60	45°
10016030	160	30/35 40/50	31-60	R 3

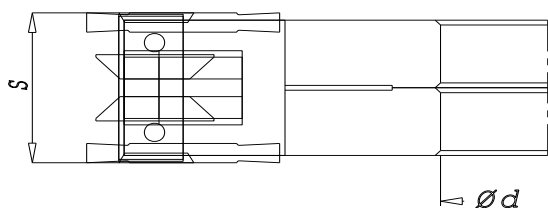

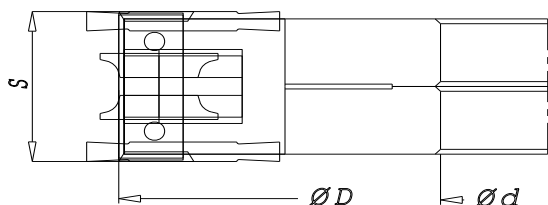

cod.10016045

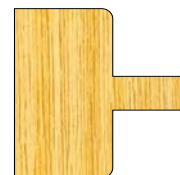
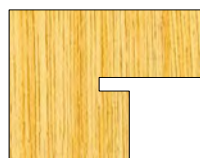
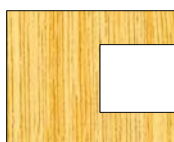

cod.10016030

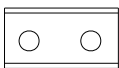

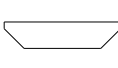
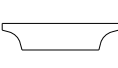
Coltelli di ricambio Spare knives					
codice / code	12013000	14140200	16010300	16452200	16302200



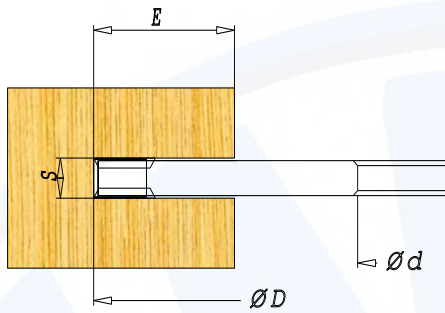

# ART. 090

Fresa per esecuzione di incastri fissi.

Grooving cutter fixed.

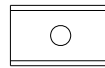
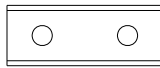

COD.	D mm	d mm	S	E	Z
09016008	160	30/35 40/50	8	50	2
09020008	200	30/35 40/50	8	70	2
09025008	250	30/35 40/50	8	90	2
09030008	300	30/35 40/50	8	115	2
09016012	160	30/35 40/50	12,6	50	2
09020012	200	30/35 40/50	12,6	70	2
09025012	250	30/35 40/50	12,6	90	2
09030012	300	30/35 40/50	12,6	115	2
09016015	160	30/35 40/50	15,6	50	2
09020015	200	30/35 40/50	15,6	70	2
09025015	250	30/35 40/50	15,6	90	2
09030015	300	30/35 40/50	15,6	115	2
09016020	160	30/35 40/50	20,6	50	2
09020020	200	30/35 40/50	20,6	70	2
09025020	250	30/35 40/50	20,6	90	2
09030020	300	30/35 40/50	20,6	115	2
09016030	160	30/35 40/50	30,6	50	2
09020030	200	30/35 40/50	30,6	70	2
09025030	250	30/35 40/50	30,6	90	2
09030030	300	30/35 40/50	30,6	115	2

Coltelli di ricambio Spare knives						
codice / code	12010760	12011200	12011500	120012000	112013000	14140200



# ART. 070

Elemento integrativo alle frese a spessore variabile per aumentarne lo spessore di regolazione

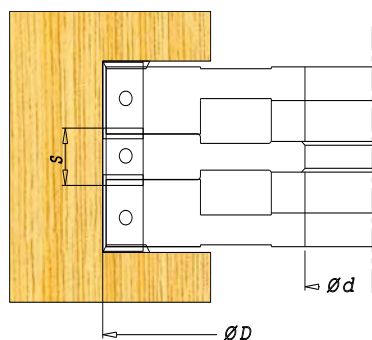
Additional element for adjustable grooving cutter which allows to extend range of adjustment



COD.	D mm	d mm	S
07016008	160	30/35 40/50	8
07016012	160	30/35 40/50	12
07016015	160	30/35 40/50	15
07020008	200	30/35 40/50	8
07020012	200	30/35 40/50	12
07020015	200	30/35 40/50	15
07025008	250	30/35 40/50	8
07025012	250	30/35 40/50	12
07025015	250	30/35 40/50	15

Coltelli di ricambio Spare knives			
codice / code	12010760	12011200	12011500



# ART. 080

Fresa per esecuzione di incastri sottili

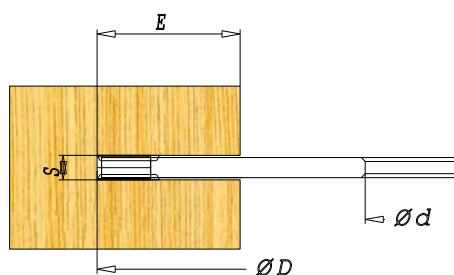
Grooving cutter for thin timber



COD.	D mm	d mm	S	E
08016006	160	30/35 40/50	6	50
08020006	200	30/35 40/50	6	70
08025006	250	30/35 40/50	6	90
08030006	300	30/35 40/50	6	115
08016008	160	30/35 40/50	8	90
08020008	200	30/35 40/50	8	70
08025008	250	30/35 40/50	8	90
08030008	300	30/35 40/50	8	115

Coltelli di ricambio Spare knives			
codice / code	18000300 ( ..06 )	18000400 ( ..08 )	14140120

# ART. 050

Fresa regolabile per esecuzione di incastri

Adjustable grooving cutter

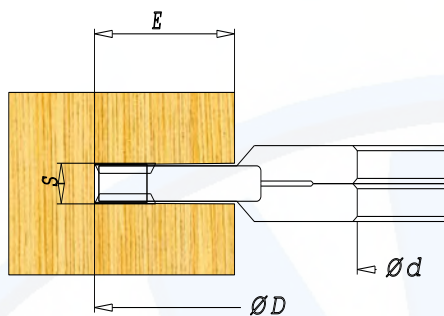

COD.	D mm	d mm	S	E
05020008	200	30/35 40/50	8-16	50
05020012	200	30/35 40/50	12,6-24	50
05020015	200	30/35 40/50	15,6-30	70
05020020	200	30/35 40/50	20,6-40	70
05020030	200	30/35 40/50	30,6-60	70

Coltelli di ricambio Spare knives						
codice / code	12010760 (..80)	12011200 (..12)	12011500 (..15)	120012000 (..20)	112013000 (..30)	14140200

# ART. 060

Fresa regolabile per esecuzione di incastri

Adjustable grooving cutter

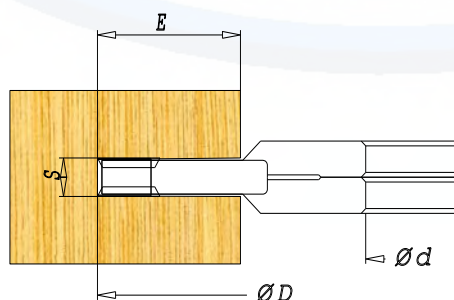

COD.	D mm	d mm	S	E
06025008	250	30/35 40/50	8-16	57
06025012	250	30/35 40/50	12,6-24	57
06025015	250	30/35 40/50	15,6-30	90
06025020	250	30/35 40/50	20,6-40	90
06025030	250	30/35 40/50	30,6-60	90

Coltelli di ricambio Spare knives						
codice / code	12010760 (..80)	12011200 (..12)	12011500 (..15)	120012000 (..20)	112013000 (..30)	14140200

# ART. 030

Fresa regolabile per esecuzione di incastri sottili

Adjustable grooving cutter for thin timber

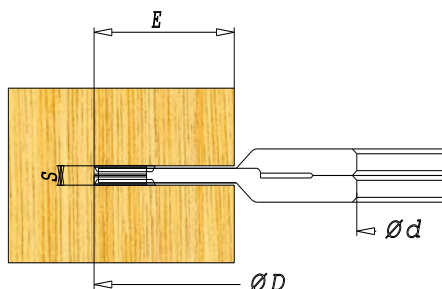

COD.	D mm	d mm	S	E
03016004	160	30/35 40/50	4-7,5	32
03020004	200	30/35 40/50	4-7,5	45
03016005	160	30/35 40/50	5-9,5	32
03020005	200	30/35 40/50	5-9,5	45



Coltelli di ricambio Spare knives			
codice / code	18000200 ( ..04 )	18000300 ( ..05 )	14140120

# ART. 040

Fresa regolabile per esecuzione di incastri

Adjustable grooving cutter

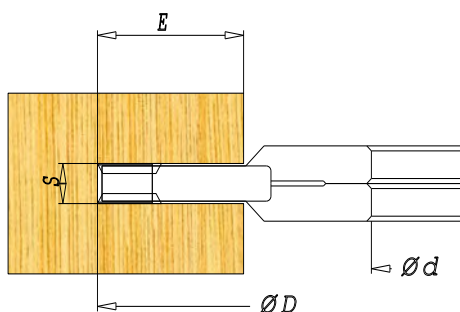

COD.	D mm	d mm	S	E
04016008	160	30/35 40/50	8-16	32
04016012	160	30/35 40/50	12,6-24	32
04016015	160	30/35 40/50	15,6-30	50
04016020	160	30/35 40/50	20,6-40	50
04016030	160	30/35 40/50	30,6-60	50

Coltelli di ricambio Spare knives						
codice / code	12010760 ( ..08 )	12011200 ( ..12 )	12011500 ( ..15 )	120012000 ( ..20 )	112013000 ( ..30 )	14140200